





# DATA SHEET

■ DEVICE NUMBER : HL-M1588BRG

(For: )

SHEET DATE	1	2	3	4	5	6	7				CONTENTS
2011.12.24	1.0	1.0	1.0	1.0	1.0						Original Released

SHENZHEN HLVLLED OPTOELECTRONIC CO.,LTD.  
4 Building Science Park Zhicheng ,No.204 Shihuan Road,  
Shiyan Town, District Baoan, Shenzhen  
Tel: 0755-23207890  
Fax: 0755-23207891  
E-Mail:chengluo@hlvled.com  
Http://[www.hlvled.com](http://www.hlvled.com)

APPROVED	DRAWER
 <p>罗 2011. 12. 24 世军</p>	 <p>王 2011. 12. 24 小燕</p>



■ Features:

1. 8×8 dot matrix display.
2. Dot Size: 3.75mm.
3. Low power consumption.
4. Lens Color : black face and translucent segments.
5. Categorized for luminous intensity.
6. RoHS compliant

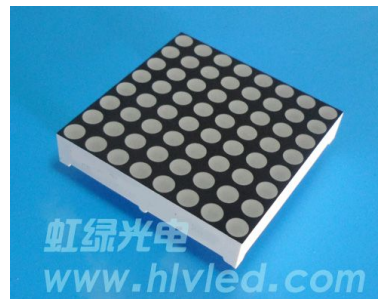

■ Device Selection Guide :

Model No.	Description	Chip	
		Material	Emitting Color
HL-M1588BRG	Common Anode	AlGaInP	Super Orange Red
		AlGaInP	Super Yellow Green

■ Mechanical Dimensions:

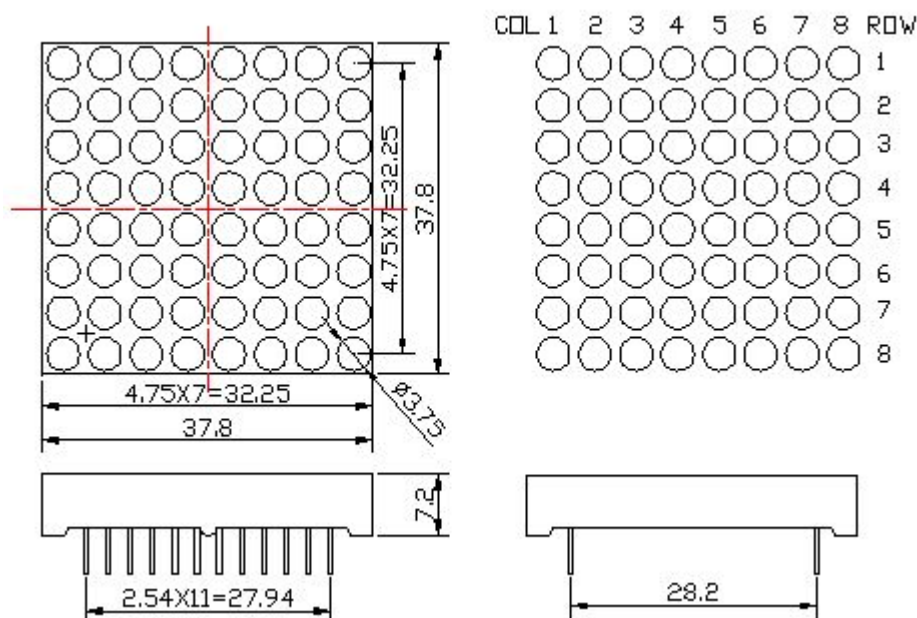

Notes:

- 1.All dimensions are in millimeters(inches).
- 2.Tolerance is  $\pm 0.25\text{mm}(.01\text{'})$  unless otherwise specified.
- 3.Specifications are subject to change without notice.



■ All Light On Segments Feature & Pin Position:

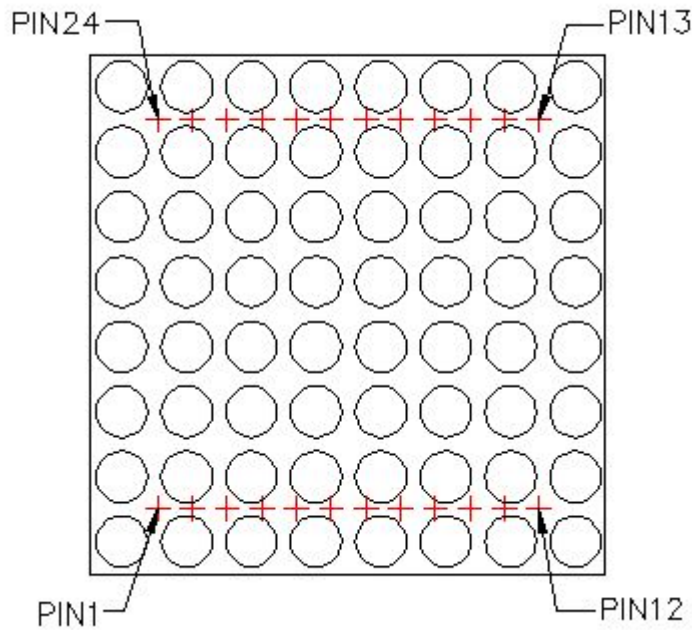

■ Internal Circuit Diagrams:

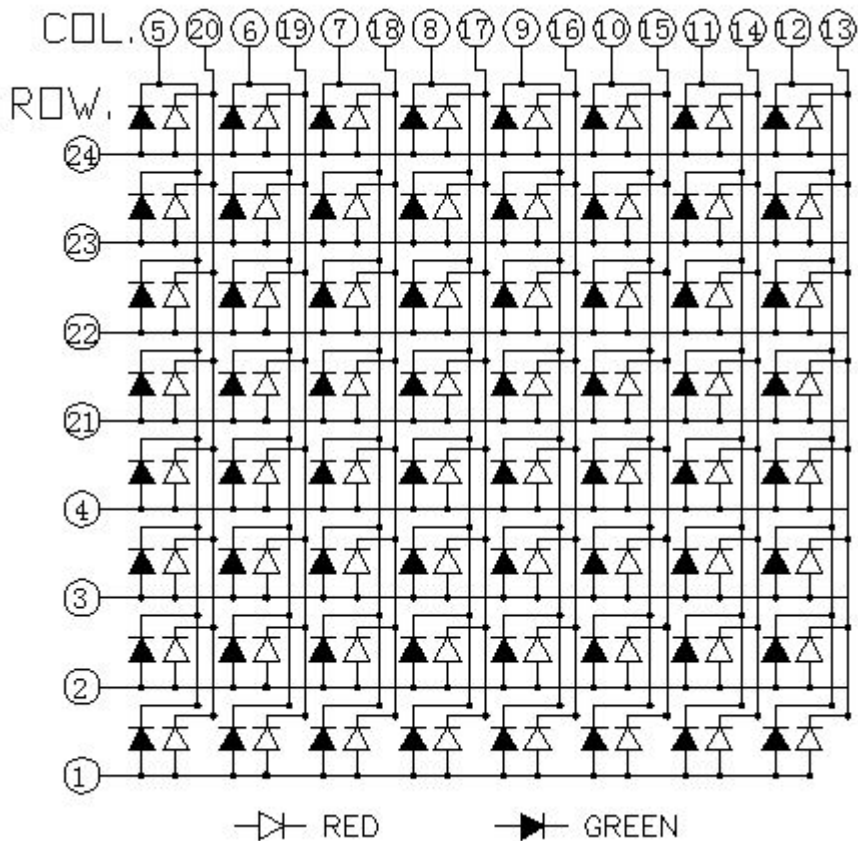



■ Absolute Maximum Ratings (Ta=25°C)

Parameter	Symbol	Rating	Unit
Pulse Forward Current*1	Pd	60	mW
Forward Current	I <sub>F</sub>	30	mA
Peak Forward Current	I <sub>FP</sub>	80	mA
Reverse Volage	V <sub>R</sub>	5	V
Operating Temperature	Topr	-40~ +105	°C
Storage Temperature	Tstg	-40~ +105	°C
Reflow Temperature*2	Tsol	260	°C
Electrostatic Discharge	ESD	2000	V

Note:

\*1: I<sub>Fp</sub> Conditions :Pulse Width ≤10msec.and Duty cycle≤1/10.

\*2: Reflow time≤5 seconds.

■ Electrical and optical characteristics (Ta=25°C)

Parameter	Symbol	Condition	Color	Typ.	Max.	Unit
Forward Voltage	V <sub>f</sub>	I <sub>F</sub> =20mA	Red	2.0	2.5	V
			Green	2.0	2.5	
Luminous Intensity/segment	I <sub>v</sub>	I <sub>F</sub> =10mA	Red	35	-	mcd
			Green	30	-	
Dominant Wave Length	λ <sub>d</sub>	I <sub>F</sub> =20mA	Red	625	-	nm
			Green	570	-	
Spectral Line Half-width	Δλ	I <sub>F</sub> =20mA	All	20	-	nm
Reverse Current	I <sub>R</sub>	V <sub>R</sub> =5V	All	-	100	μA



■ Reliability test items:

No.	Test Item	Test Condition	Time/Cycle	Judgment Criteria	Number Damaged
1	Reflow Soldering	TEMP: 260°C± 5°C MAX: 5sec	6 Min	Iv≤Ivt*0.5 Vf≥U Vf≤L	0/30
2	Thermal shock	H: +100°C 5min L: -40°C 5min	300 Cycles		0/30
3	High temp storage	100°C	1000 Hrs		0/30
4	Low temp storage	-40°C	1000 Hrs		0/30
5	Temperature cycle	H: +100°C 15min L: -40°C 15min	300 Cycles		0/30
6	High temp high humidity	85°C,85%RH	1000 Hrs		0/30

Note: Ivt: The test Iv value of the chip before the reliability test.

IV: The test value of the chip that has completed the reliability test.

U: Upper Specification Limit.

L: Lower Specification Limit.

■ IR Reflow temperature/Time:

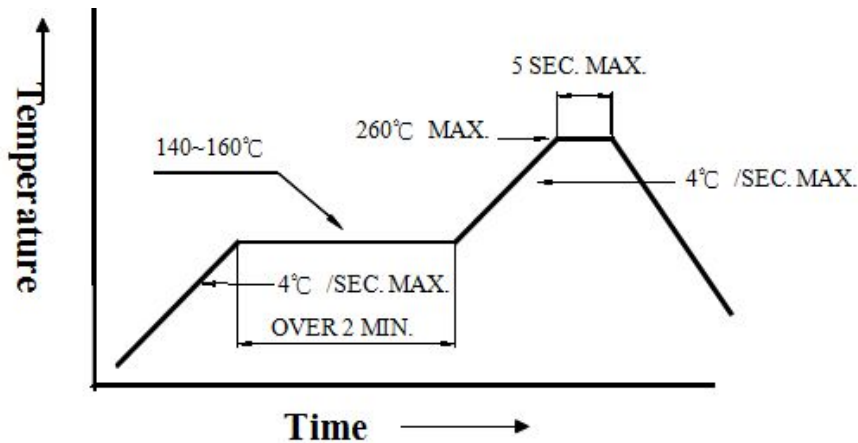

■ Soldering Iron:

Ferrochromium soldering: power keep no more than 40W, tip temperature should not pass 260°C, soldering Time Within 3 second.