





## DATA SHEET

■ DEVICE NUMBER : HLS-2021BR

(For: )

SHEET DATE	1	2	3	4	5	6	7				CONTENTS
2011.12.24	1.0	1.0	1.0	1.0	1.0	1.0					Original Released

SHENZHEN HLVLLED OPTOELECTRONIC CO.,LTD.  
4 Building Science Park Zhicheng ,No.204 Shihuan Road,  
Shiyan Town, District Baoan, Shenzhen  
Tel: 0755-23207890  
Fax: 0755-23207891  
E-Mail:chengluo@hlvled.com  
Http://[www.hlvled.com](http://www.hlvled.com)

APPROVED	DRAWER
 <p>罗 2011. 12. 24 世军</p>	 <p>王 2011. 12. 24 小燕</p>



■ **Features:**

1. 0.2 inch (5.08mm) Digit Height.
2. Low power consumption.
3. Lens Color : Gray face and white segment.
4. Categorized for luminous intensity.
5. RoHS compliant

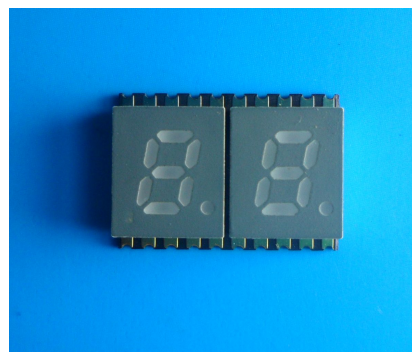

■ **Device Selection Guide :**

Model No.	Description	Chip	
		Material	Emitting Color
HLS-2021BR	Common Anode	AlGaInP	Super Orange Red

■ **Mechanical Dimensions:**

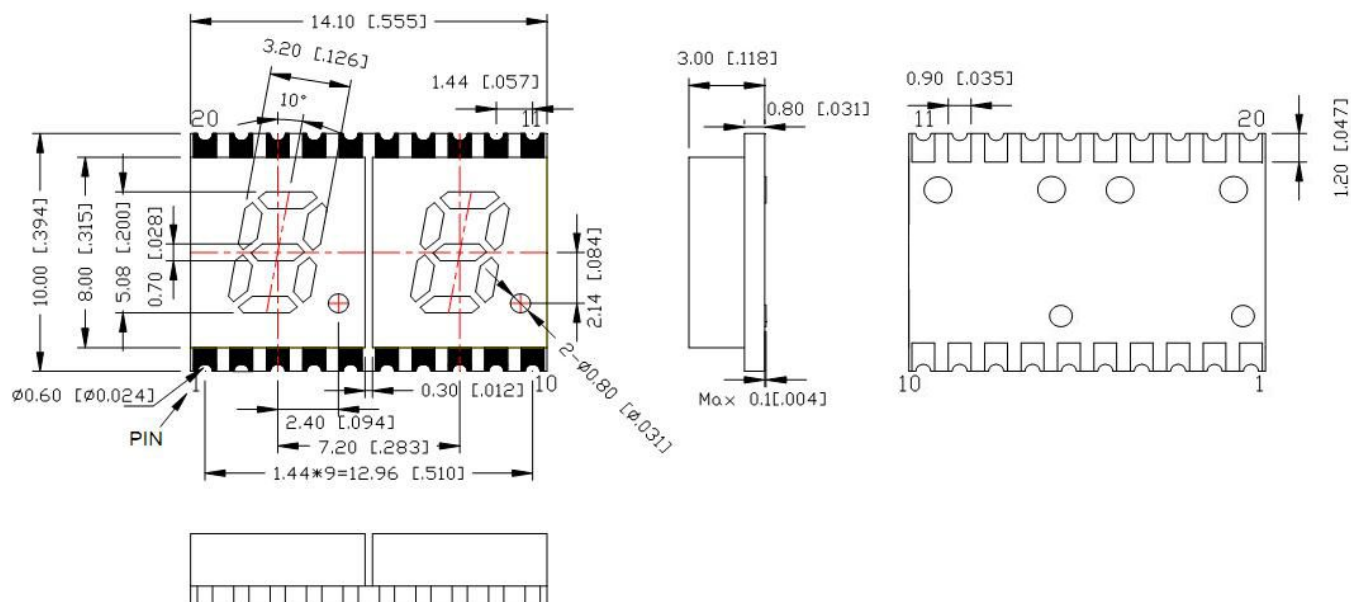

Notes:

1. All dimensions are in millimeters(inches).
2. Tolerance is  $\pm 0.25\text{mm}(.01\text{'})$  unless otherwise specified.
3. Specifications are subject to change without notice.



Internal Circuit Diagrams:

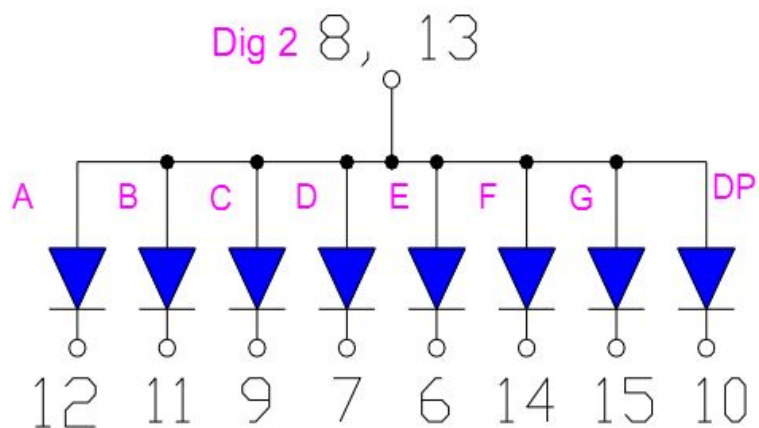
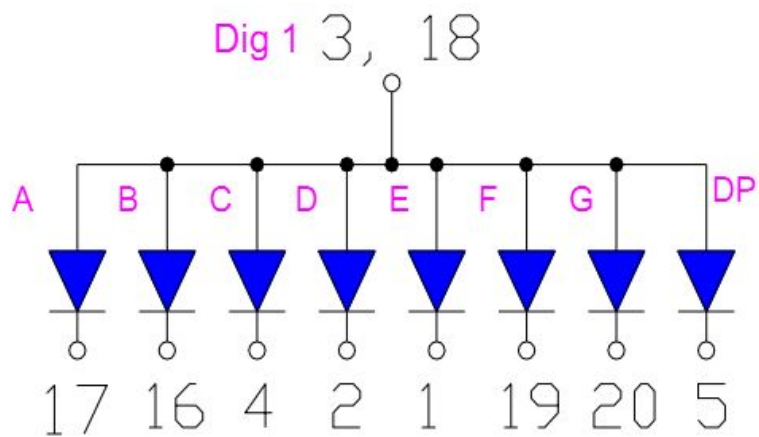
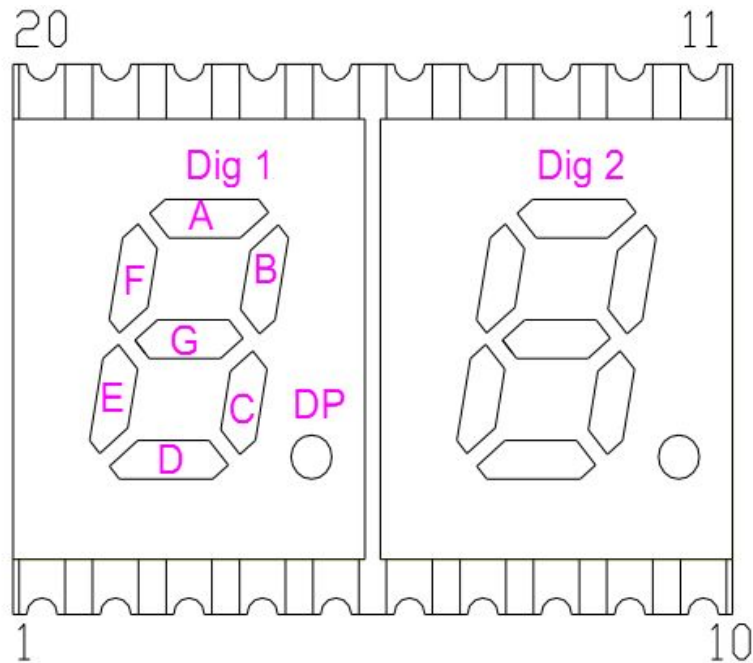



■ Absolute Maximum Ratings (Ta=25°C)

Parameter	Symbol	Rating	Unit
Pulse Forward Current*1	Pd	60	mW
Forward Current	I <sub>F</sub>	30	mA
Peak Forward Current	I <sub>FP</sub>	80	mA
Reverse Volage	V <sub>R</sub>	5	V
Operating Temperature	Topr	-40~ +105	°C
Storage Temperature	Tstg	-40~ +105	°C
Reflow Temperature*2	Tsol	260	°C
Electrostatic Discharge	ESD	2000	V

Note:

\*1: I<sub>Fp</sub> Conditions :Pulse Width ≤10msec.and Duty cycle ≤1/10.

\*2: Reflow time ≤5 seconds.

■ Electrical and optical characteristics (Ta=25°C)

Parameter	Symbol	Condition	Min.	Typ.	Max.	Unit
Forward Voltage	V <sub>f</sub>	I <sub>F</sub> =20mA	-	2.0	2.5	V
Luminous Intensity/segment	I <sub>v</sub>	I <sub>F</sub> =10mA	5	12	-	mcd
Reverse Current	I <sub>R</sub>	V <sub>R</sub> =5V	-	-	100	μA
Peak Wave Length	λ <sub>p</sub>	I <sub>F</sub> =20mA		630		nm
Dominant Wave Length	λ <sub>d</sub>	I <sub>F</sub> =20mA	620	-	630	nm
Spectral Line Half-width	Δλ	I <sub>F</sub> =20mA	-	20	-	nm



■ Typical Electro-Optical Characteristics Curves

(25°C Ambient Temperature Unless Otherwise Noted)

Fig.1 Relative Radiant Intensity VS. Wavelength

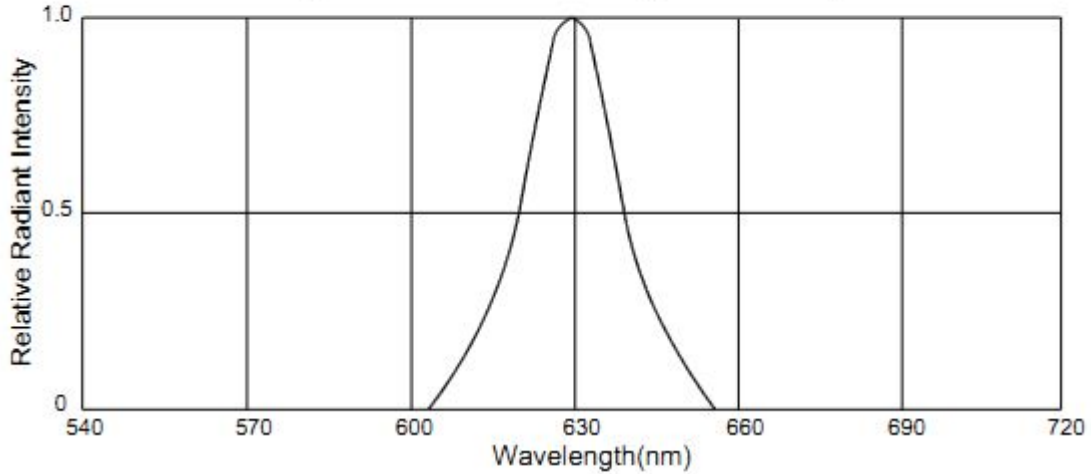

Fig.2 Forward Current VS. Forward Voltage

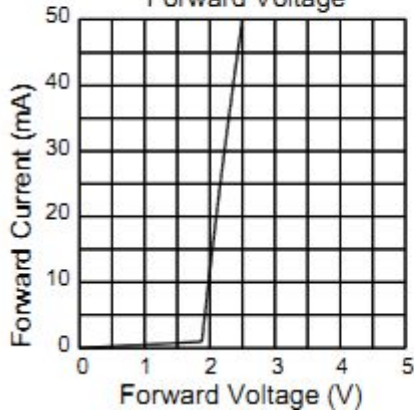

Fig.3 Relative Luminous Intensity VS. Ambient Temperature

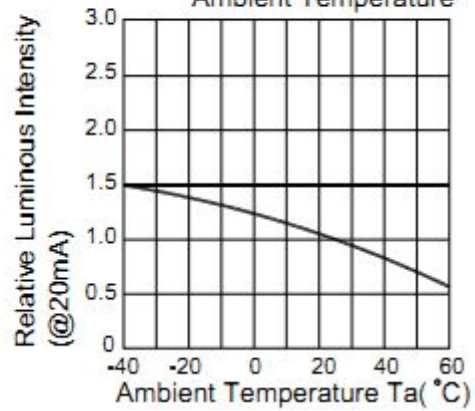

Fig.4 Relative Luminous Intensity VS. Forward Current

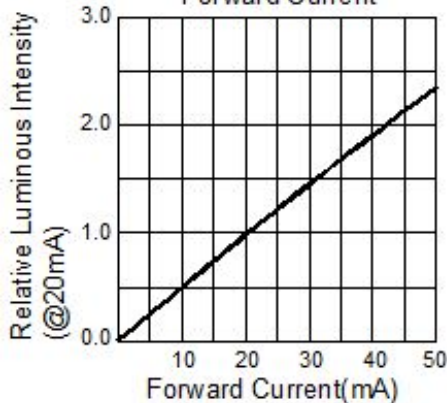
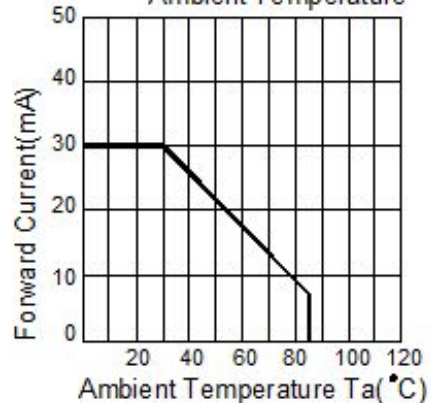

Fig.5 Forward Current Derating Curve VS. Ambient Temperature





■ Reliability test items:

No.	Test Item	Test Condition	Time/Cycle	Judgment Criteria	Number Damaged
1	Reflow Soldering	TEMP: 260°C± 5°C MAX: 5sec	6 Min	Iv≤Ivt*0.5 Vf≥U Vf≤L	0/30
2	Thermal shock	H: +100°C 5min L: -40°C 5min	300 Cycles		0/30
3	High temp storage	100°C	1000 Hrs		0/30
4	Low temp storage	-40°C	1000 Hrs		0/30
5	Temperature cycle	H: +100°C 15min L: -40°C 15min	300 Cycles		0/30
6	High temp high humidity	85°C,85%RH	1000 Hrs		0/30

Note: Ivt: The test Iv value of the chip before the reliability test.

IV: The test value of the chip that has completed the reliability test.

U: Upper Specification Limit.

L: Lower Specification Limit.

■ IR Reflow temperature/Time:

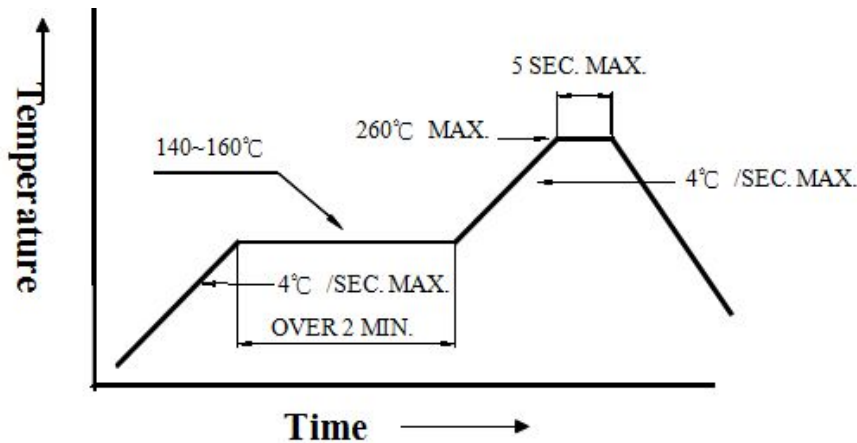

■ Soldering Iron:

Ferrochromium soldering: power keep no more than 40W, tip temperature should not pass 260°C, soldering Time Within 3 second.





■ Reel Dimensions:

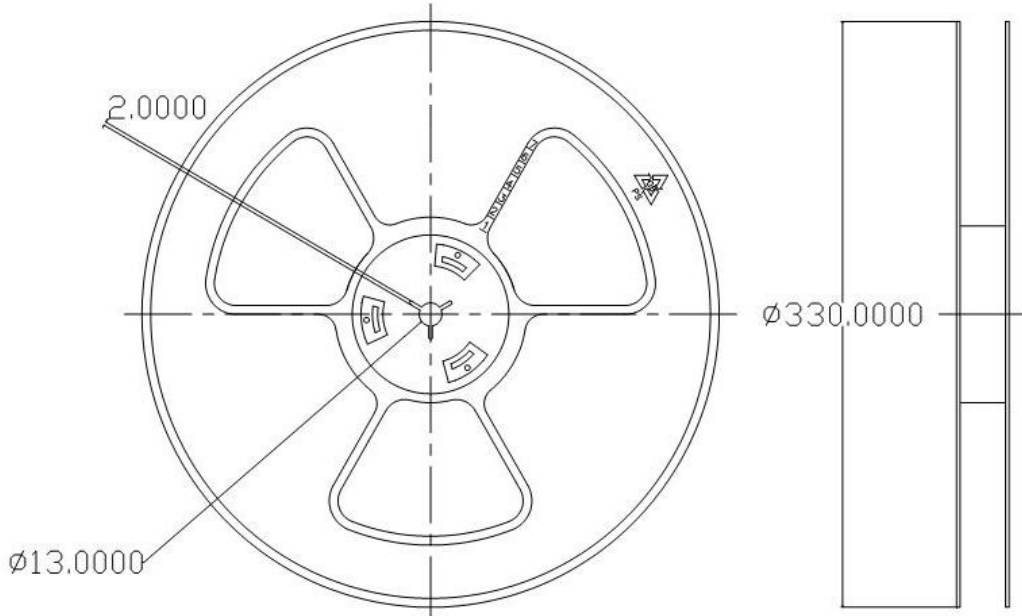

■ Packing & Label Specification:

